

# operating and maintenance INSTRUCTIONS

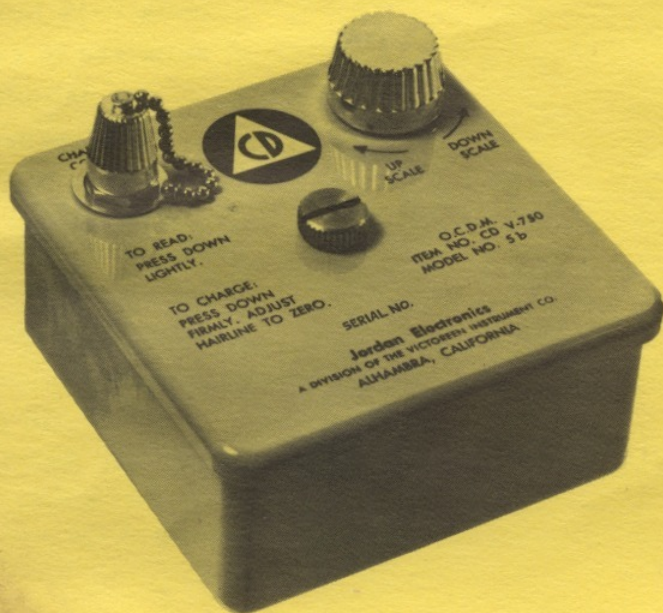

## Radiological Dosimeter Charger Jordan Model 750-5

OCDM Item No. CD V-750 — Model No. 5b

### Jordan Electronics

A DIVISION OF THE VICTOREEN INSTRUMENT COMPANY

ALHAMBRA, CALIFORNIA





---

## TABLE OF CONTENTS

---

	<i>Page</i>
<b>1.0 general description</b> . . . . .	2
<b>2.0 theory of operation</b> . . . . .	3
<b>3.0 installation</b> . . . . .	4
<b>4.0 operation</b> . . . . .	4
4.1 Dosimeter Reading . . . . .	4
4.2 Dosimeter Charging . . . . .	4
4.3 Emergency Operation . . . . .	5
<b>5.0 operator's maintenance</b> . . . . .	5
<b>6.0 preventive maintenance</b> . . . . .	5
<b>7.0 corrective maintenance</b> . . . . .	5
<b>8.0 parts list</b>	
8.1 Electrical Parts . . . . .	6
8.2 Mechanical Parts (replaceable) . . . . .	8
8.3 Names and Addresses of Manufacturers . . . . .	8

### **illustrations**

Figure 1 — Top and Bottom View of CD V-750 . . . . .	2
Figure 2 — Schematic . . . . .	7
Figure 3 — Voltage Waveshape . . . . .	7
Figure 4 — Wiring Diagram . . . . .	7

# operating and maintenance instructions

## 1.0 GENERAL DESCRIPTION

The V-750 Radiological Dosimeter Charger supplies the voltage required to charge or "ZERO" quartz fibre dosimeters.

A transistor oscillator converts the direct current from a flashlight battery to alternating current so that the transformer can "step up" the battery voltage (1.5 volts) to the 220 volts required by the dosimeter. A voltage control is used to adjust the output voltage to the exact value required to bring the dosimeter to zero.

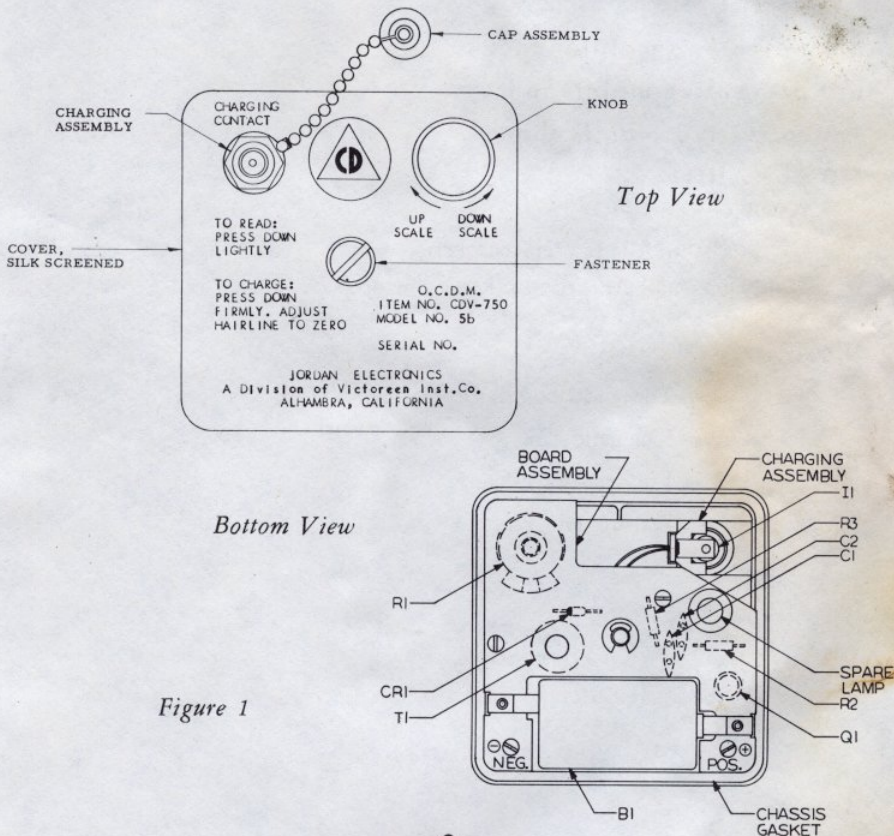

Figure 1

## 2.0 THEORY OF OPERATION

The operation of the dosimeter charger circuit is governed mainly by the magnetic properties of the iron core of the transformer. The transistor serves as a switch to control the flow of current through the transformer primary winding.

Refer to the circuit schematic Fig. 2, Page 7.

The switch  $SW_1$  is closed when the charging pedestal is depressed by the dosimeter. Current flows from the positive (+) electrode of the battery B through the bulb I to provide illumination for the dosimeter scale.

With the switch  $SW_1$  closed, a small current flows out of the positive (+) electrode of the battery through winding  $N_1$  of transformer  $T_1$ , into the emitter (e) of the transistor  $Q_1$ , out of the base (b), and through resistor  $R_3$  to the negative (-) electrode of the battery. This base current allows a much larger current to flow into the emitter (e) and out of the collector (c) to the negative (-) electrode of the battery.

The large current flowing into the emitter (e) through  $N_1$  creates a magnetic flux in the transformer core. The increases in flux induces a voltage in  $N_2$  that tends to drive the base (b) of the transistor more negative and causes more base current to flow. This in turn causes more collector current to flow and so on until the transistor becomes "saturated" and no further increase takes place. This action is completed very rapidly.

The voltage induced in the other windings by current through  $N_1$  depends on the ratio of increase of magnetic flux in the transformer core and turns ratio. When the core becomes fully magnetized, the flux can increase no more and therefore, the rate of increase drops to zero and the transformer action ceases.

When the core becomes magnetized and transformer action ceases, the voltage induced into  $N_2$  and applied to the base of the transistor drops to zero and the transistor collector current stops flowing. Now, with no current flowing through  $N_1$ , the magnetic flux in the transformer drops very rapidly. This rapid reverse change in flux induces a large reverse voltage in the secondary winding  $N_3$  for a short period of time. This completes the cycle and the process repeats itself as long as the switch  $SW_1$  remains closed.

Each high voltage pulse in the secondary  $N_3$  causes current to flow into the capacitor  $C_2$  for a short period of time. The energy of the pulse is stored in the capacitor and the voltage across the capacitor can be "pumped up" by these repetitive high voltage pulses to nearly the peak voltage of the pulses. The rectifier diode  $CR_1$  passes only positive pulses to the capacitor  $C_2$ .

The waveshape seen with an oscilloscope connected to the secondary  $N_3$  is shown on Page 7.

The potentiometer resistor  $R_1$  and the fixed resistor  $R_2$  serve as a voltage divider across the capacitor. The potentiometer  $R_1$  is the control use to adjust the voltage applied to the dosimeter at the charging pedestal  $J_1$ .

During the interval between pulses, part of the charge on  $C_2$  leaks off through  $R_1$  and  $R_2$ . Therefore, a fast pulse repetition rate will result in the highest voltage on  $C_2$ . The repetition rate, and thus the voltage on  $C_2$  is controlled by turning the core inside the transformer which in turn varies the coupling between windings. This coupling adjustment is used to obtain the proper voltage range to charge dosimeters. The adjustment of the transformer core is made at the factory and should not be altered except for emergency operation as described in paragraph 4.3.

The capacitor  $C_1$  serves the purpose of assuring that the circuit will function properly at temperature extremes by forcing the voltage between the emitter and collector to increase more rapidly than the voltage between base and collector, when the switch is closed.

### 3.0 INSTALLATION

Preparation of the dosimeter charger for operation is quite simple. Remove the case by loosening the case fastener. The knurled head can be turned with the fingers or, if it is too tight, with a coin inserted in the slot.

Install the 'D' cell in the opening provided for it in the printed circuit board. Observe the polarity markings on the battery and the printed circuit. The battery will fit in the holder only one way. DO NOT attempt to force it into position.

Replace the case and tighten fastening screw with fingers.

Unscrew the dust cap from the charging contact and the charger is ready for use.

### 4.0 OPERATION

#### 4.1 dosimeter reading

To read a dosimeter, place it on the charging contact and press down lightly to switch on the light. Do not press harder than necessary or the reading will be lost.

#### 4.2 dosimeter charging

To charge a dosimeter, press it down on the charging contact with sufficient force to bring the dosimeter body in contact with the threaded portion of the charging assembly.

This will provide sufficient force to actuate the charging switch in the dosimeter. Now read the dosimeter and adjust the control knob until the dosimeter indicates ZERO.

Remove the dosimeter from the charging contact.

### 4.3 emergency operation

When the 'D' cell is nearly discharged and a new one is not available, the dosimeter charger can still be made to operate. Two steps can be taken:

- a. Open the case and, with an alignment tool, adjust the transformer core in the direction marked DOWN SCALE. This will increase the charging voltage to compensate for the lost battery voltage.
- b. If step "a" still does not provide sufficient voltage to bring the dosimeter to zero, remove the lamp  $I_1$ . The lamp requires much more current than the charging circuit. The battery may have enough energy to operate the charging circuit, but not the lamp.

Without the lamp it will be necessary to make adjustments in small steps while reading the dosimeter each time with another source of illumination.

### 5.0 OPERATOR'S MAINTENANCE

Operator's maintenance should be limited to replacing the battery, cleaning the contacts and inspecting for visible faults. If the lamp appears dim or does not light, replace the battery. If operation is intermittent, clean the battery contacts.

If the lamp is bright, but the dosimeter cannot be brought to ZERO, try another dosimeter. If none of the dosimeters can be charged, check for contamination on the charging contact insulator or for a short circuit on the charging contact wire inside the charger.

### 6.0 PREVENTIVE MAINTENANCE

The only preventive maintenance required is removal of the battery when the dosimeter charger is to be stored, and cleaning the battery contacts if they appear corroded.

### 7.0 CORRECTIVE MAINTENANCE

When a malfunction cannot be corrected by the steps outlined in Section 5, further steps can be taken by a competent electronic technician.

Reference should be made to the schematic diagram, figure 2 and the wiring diagram, figure 4 on page 7.

Improper adjustment of the transformer core can prevent operation. To adjust, turn the control knob  $R_1$  full clockwise. Connect the negative lead of 20,000 ohm/V multimeter (Simpson 260 or equal) to the chassis. Set the meter to the 250V DC range. Connect the positive lead to the charging contact wire. Depress the charging pedestal to close the switch.

Starting from the full counter clockwise position, turn the transformer core clockwise until the meter indicates 57 volts.

If no voltage is obtained, replace the transistor. Almost any small PNP transistor will probably work.

If a new transistor doesn't work, remove  $C_2$  and check for shorts with an ohmmeter. Check the rectifier diode  $CR_1$  with an ohmmeter. Set the meter to the RX10 scale. With the meter leads connected one way, it should show a short, and the other way an open. If it shows a short or open both ways, replace it.

Check  $R_1$ ,  $R_2$  and  $R_3$  with an ohmmeter. Check the transformer windings for continuity and interwinding shorts with an ohmmeter.

Inspect the printed circuit for damage and check all connections to it.

Across winding  $N_3$  the waveform should look like the sketch in figure 3, and may be observed on an oscilloscope.

## 8.0 PARTS LIST

### 8.1 electrical parts

Circuit Symbol	Description & Function	Mfgr. & Part No.	Jordan Part No.	Recommended Spares
$B_1$	Battery, 'D' Cell	Eveready 950	BA-0005	10
$C_1$ & $C_2$	Capacitor, Cermaic Disc, .002 uf 500V (High Voltage Filter & Starting)	Aerovox HIK.002-Y5U-Z-88	CC-0014	4
$CR_1$	Diode, 250 PIV (High Voltage Rectifier)	G.I. HP162	QD-0021	1
$I_1$	Lamp, I-131 (Scale Illumination)	CMLW-131	EL-0003	2
$Q_1$	Transistor, PNP (Oscillator)	G.E. TO-5	QT-0033	2
$R_1$	Potentiometer, 10 Meg $\frac{1}{4}$ W 30% (Control)	CTS UP-45(31998)	RP-0106	2
$R_2$	Resistor, Carbon 3.9 Meg $\frac{1}{2}$ W 10% (Voltage Divider)	IRC GBT $\frac{1}{2}$	RC-0395	2
$R_3$	Resistor, Carbon 27K $\frac{1}{2}$ W 10% (Transistor Biasing)	IRC GBT $\frac{1}{2}$	RC-0273	2
$T_1$	Transformer (Oscillator)	Jordan	TX-0002	1

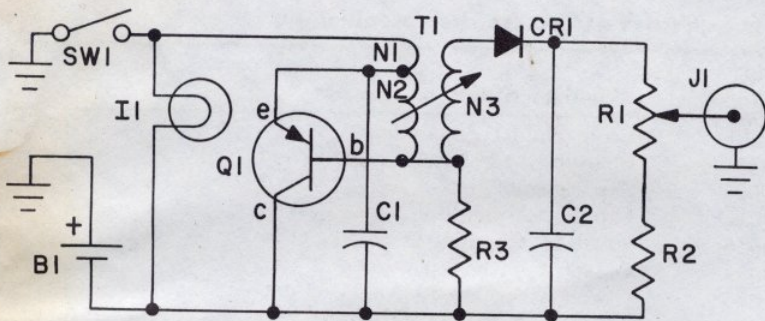

Figure 2 — Schematic

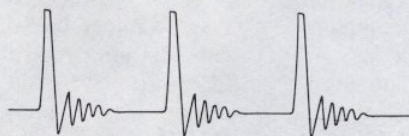

Figure 3 —  
Voltage Waveshape

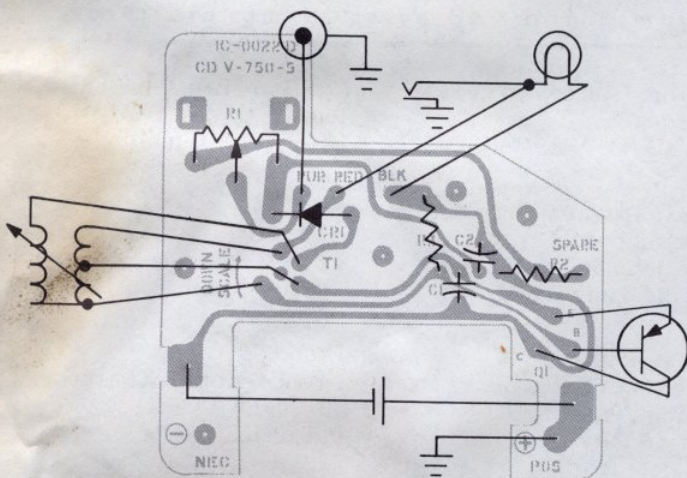

Figure 4 — Wiring Diagram

## 8.2 mechanical parts (replaceable)

Jordan Part No.	Description	Recommended Spares
AE-0340	Lamp Holder Assembly	1
AI-0035	Charging Pedestal Assembly	1
AM-0022	Cap Assembly	1
HG-0016	Grommet, Spare Bulb	1
HG-0036	'O' Ring, Charging Pedestal	1
HG-0084	Gasket, Case Fastener	2
HG-0085	Gasket, Charging Assembly	1
HG-0086	'O' Ring, Potentiometer Shaft	1
HG-0087	Gasket, Chassis	2
HW-1007	Lockwasher, Charging Assembly	1
HX-0285	Washer, 'C' Case Fastener Retaining	5
HX-0286	Set Screw, #10-32 x 1/4 cup slotted	5
HX-0290	Screw, #4-40 x 1/4 Self Tapping	10
HX-0291	Nut, Charging Assembly	5
IC-0022	Board, Printed Circuit	2
MD-0013	Chassis	1
MD-0014	Knob, Control	1
MM-0518	Guide, Charging Pedestal	1
MM-0447	Fastener, Case	1
MS-0578	Light Spring	1
MS-0579	Main Spring	1

## 8.3 names and addresses of manufacturers

<i>Eveready</i>	<i>CMLW</i>
NATIONAL CARBON COMPANY 535 Fifth Ave. New York 17, New York	CHICAGO MINIATURE LAMP WORKS 1500 N. Ogden Ave. Chicago 10, Illinois
<i>GI</i>	<i>CTS</i>
GENERAL INSTRUMENT CORP. SEMICONDUCTOR DIV. 600 W. John St. Hicksville, Long Island, New York	CHICAGO TELEPHONE SUPPLY CORP. 1142 W. Beardsley Ave. Elkhart, Indiana
<i>GE</i>	<i>IRC</i>
GENERAL ELECTRIC SEMICONDUCTOR PRODUCTS DEPT. Electronics Park Syracuse 5, New York	INTERNATIONAL RESISTANCE CO. 401 N. Broad St. Philadelphia 8, Pa.
<i>Aerovox</i>	<i>Jordan</i>
AEROVOX CORP. 740 Belleville Ave. New Bedford, Mass.	JORDAN ELECTRONICS Alhambra, California

## MODIFICATION INSTRUCTIONS

### RADIOLOGICAL DOSIMETER CHARGER OCDM ITEM No. CD V-750, Model 5b

1. After an extended period of storage, the dosimeter actuated switch (SW 1) has been found to be erratic. This causes the dosimeter to read up-scale when removed from the charger after it had been set to zero.
2. The up-scale "kick" observed in the dosimeter is caused by the switch (SW 1) in the charger failing to maintain contact and hold the charging voltage up until the dosimeter is completely removed.
3. This condition is corrected by adding a .035uf capacitor (C3) to the charger to store the charge and hold the voltage up until the dosimeter is completely removed.
4. The capacitor is connected as shown in Figure 1. The corrected schematic is shown in Figure 2. It can be seen that the capacitor is connected directly across the charging electrode.
5. To install the capacitor (C 3), the following steps are required:
  - (a) The capacitor has a lug attached to one wire. Loosen Screw A one full turn, but don't remove the screw. Slip the lug under the screw and tighten.
  - (b) Loop the other wire around Terminal B, solder and clip off the excess wire.
  - (c) Dress the capacitor C 3 tight against the board so that it will not touch the case or any sharp pointed wires or terminals on the board.
6. Check the control potentiometer. If it does not rotate freely, the 'O' ring may need lubrication. If this is the case, remove the knob and press on the shaft to deflect the circuit board about  $\frac{1}{16}$ " to loosen the 'O' ring. Now place a small amount of the 'O Lube' down around the shaft and replace the knob.
7. Insert one of these sheets in each instruction booklet.

JUN -- 1965

SWITCH MODIFICATION PERFORMED

Date:

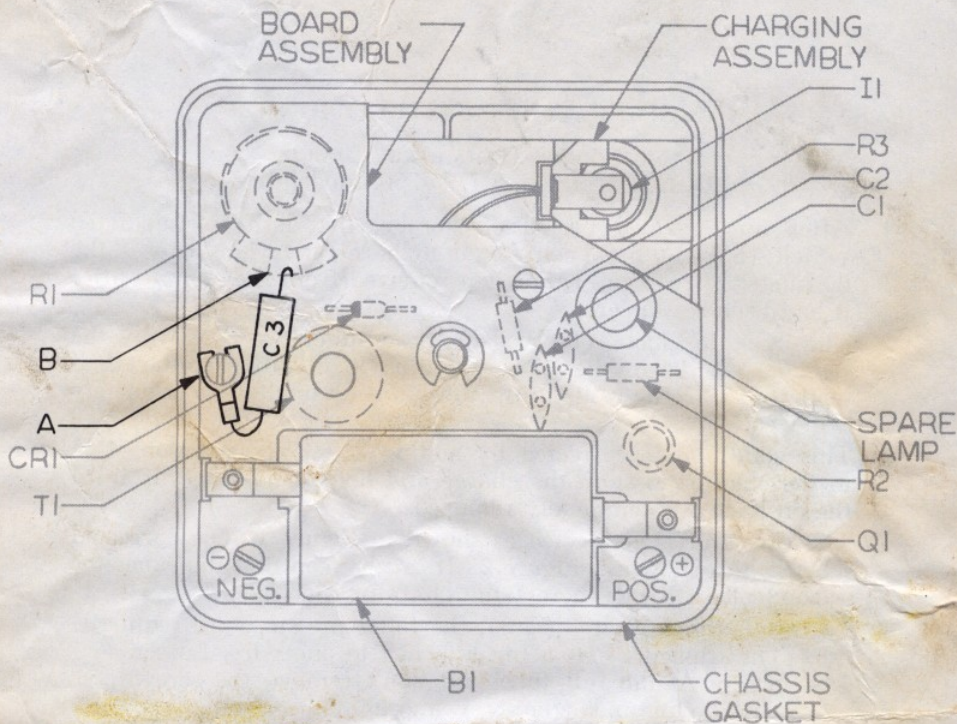

Figure 1.

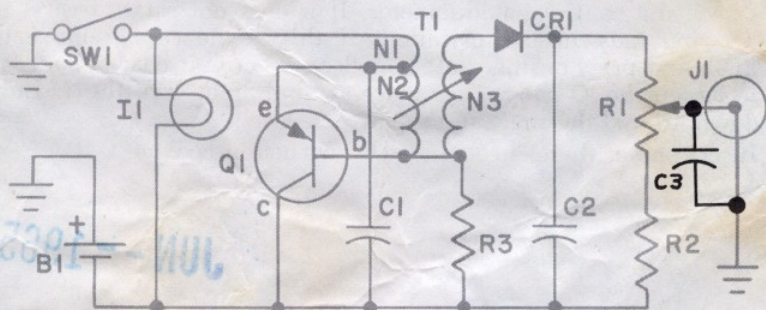

Figure 2.